

SET POLAR 3X

www.domusline.com

Under cabinet luminaire
for accent lighting

| Device with non-replaceable LED module

**Product features**

Housing:	aluminium
Diffuser:	methacrylate
Wiring:	2000mm
Connector:	Micro24
Switch	not included
N. LEDs:	24
Durability:	30,000 h ¹

**Technical Data**

Wattage:	5 W
Voltage:	24Vdc ²
Insulation degree:	III ²
Socket/Type:	LED

1_ average value (minimum guaranteed complies with the requirements of EU Regulation 1194/2012)
2_ Referred to Polar luminaire

Code	Watt & Volt	Light colour	Finish	EAN	Intrastat Number
2226305N	3x5W @ 230Vac	natural white	aluminium	8027934224847	94054099
2226305B	3x5W @ 230Vac	warm white	aluminium	8027934219324	94054099
2226305B1	3x5W @ 230Vac	super warm white	aluminium	8027934239940	94054099



Scan for installation manual

LED CONVERTER INCLUDED.

polarized connector for 24Vdc luminaire



Constant voltage converter included

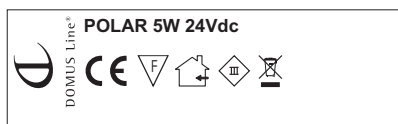

Referred to Polar luminaires

Marks and symbols

Device in compliance with the EN60598 regulation-last edition.



Protection class III device. Power must be supplied by a safe power supply (in accordance with the EN61347-2-13 standard).



Device suitable for mounting in or on normally flammable surfaces.



Device only for indoor installation.



Device subject to the European Community directives 2002/96/CE and 2003/108/CE.

SET POLAR 3X

www.domusline.com

Under cabinet luminaire
for accent lighting

| Device with non-replaceable LED module

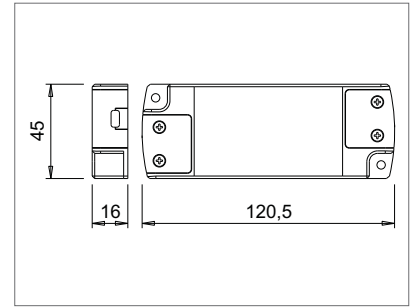
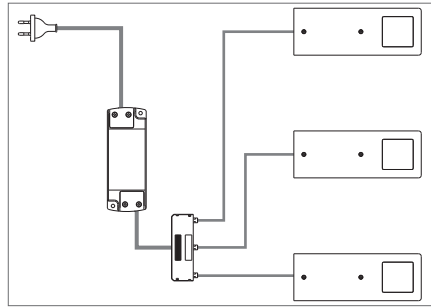
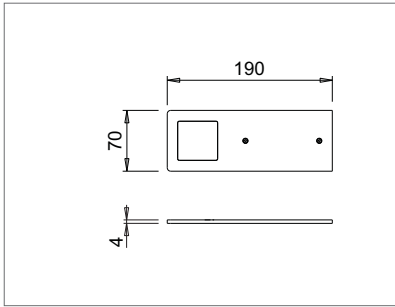

Scan for more info
about power supply

Photometric Data³

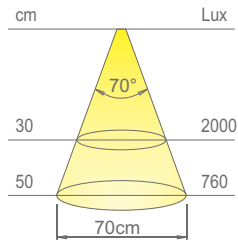

Colour appearance: natural white
Color temperature: 4000 Kelvin
Luminous efficiency: 80 lm/W
CRI: Ra 80
Binning: Variation of chromaticity coordinates within a MacAdam ellipse

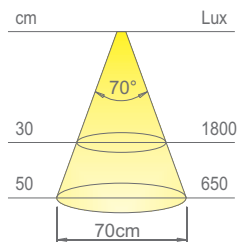

Colour appearance: warm white
Color temperature: 3100 Kelvin
Luminous efficiency: 75 lm/W
CRI: Ra 80
Binning: Variation of chromaticity coordinates within a MacAdam ellipse

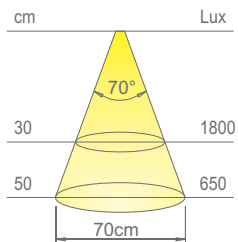

Colour appearance: super warm white
Color temperature: 2700 Kelvin
Luminous efficiency: 75 lm/W
CRI: Ra 80
Binning: Variation of chromaticity coordinates within a MacAdam ellipse

³_average value (minimum guaranteed complies with the requirements of EU Regulation 1194/2012)

SET POLAR 3X

www.domusline.com

Under cabinet luminaire
for accent lighting

| Device with non-replaceable LED module

Energy label

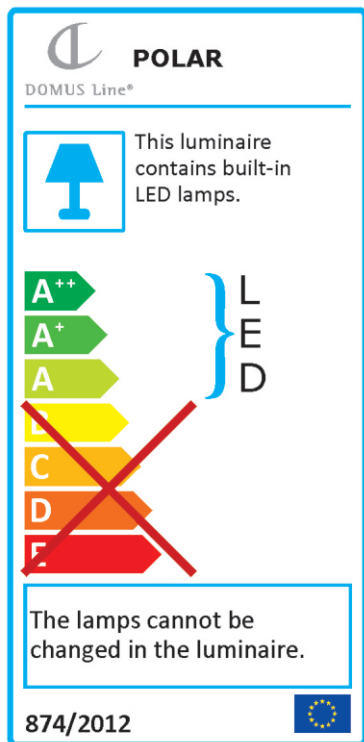

Scan for more info

Compliance

Standards : EN 60598-1:2008+A11:2009 EN 61000-3-2/A1/A2:2011
 EN 60598-2-2:2012 EN 61000-3-3:2009
 EN 62031:2009 EN 61547:2009
 EN 55015:2008
 EN 62471:2009
 EN 50581:2012

European Directives : 2014/35/EU Low Voltage
 2014/30/EU EMC
 2009/125/CE Erp (1194-2012-CE)
 2011/65/UE RoHS

Photobiological Safety: risk 0 (free)

Certificate/s:

Packaging data

	Pcs	Dimensions LxWxH (mm)	Gross weight	Net weight
Packaging unit:	1 pcs	250x130x60	0,712 Kg	0,651 Kg
Multibox unit:	12 pcs	390x300x330	9,115 Kg	7,812 Kg