



# VOLARE

Inteligência em movimento





Somos a inteligência presente em cada movimento.  
A tecnologia por trás de cada solução.  
Para transformar espaços,  
estamos em constante evolução.

Somos dedicados e especialistas.  
Estudamos cada detalhe em profundidade.  
Projetamos, analisamos, aperfeiçoamos.  
Sempre em busca do movimento perfeito.

Trabalhamos para impactar positivamente o cotidiano.  
Criando ou desenvolvendo produtos que valorizam  
móveis e espaços contemporâneos.  
Com performance, conforto, design.  
E a segurança de uma empresa que ama criar.

Somos pioneiros em compartilhar experiências.  
Acreditamos na inovação como um projeto de vida.  
Construído com confiança e excelência.  
Para transformar a sua relação com o seu mundo.

**Rometal.**



# Movimento para transformar

## Missão

Entregar soluções que proporcionem conforto, segurança e design, para transformar positivamente a relação das pessoas com o seu móvel e seu espaço.

## Visão

Ser, até 2026, a empresa brasileira de maior reconhecimento nos mercados atuantes pela confiança em nossos produtos e serviços, resultando na escolha da marca pelas pessoas.

## Valores

Proximidade

Inovação

Confiança

Colaboração

Descomplicar

Excelência



## Sistema para porta de passagem OCULTO

Nova proposta de sistema deslizante, onde a ferragem fica totalmente oculta, dando a impressão que a porta está flutuando, o que garante leveza e fluidez ao espaço.



O Volare é um sistema suspenso para portas de passagem. Com amortecimento e design inovador, este sistema conta com ferragens totalmente ocultas, tanto na abertura como no fechamento da porta.





Portas de até 80 Kg



Portas de madeira



Sistema de amortecimento

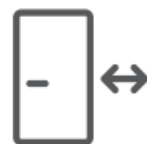

Largura da porta:  
de 800 a 1220 mm



Antidescarrilamento



Sistema suspenso



## COMPOSIÇÃO DO KIT E MONTAGEM



## COMPOSIÇÃO DO KIT: COMPONENTES

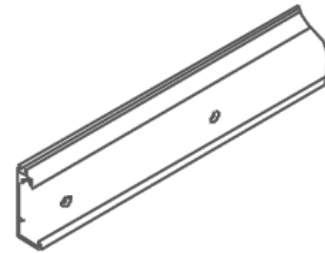
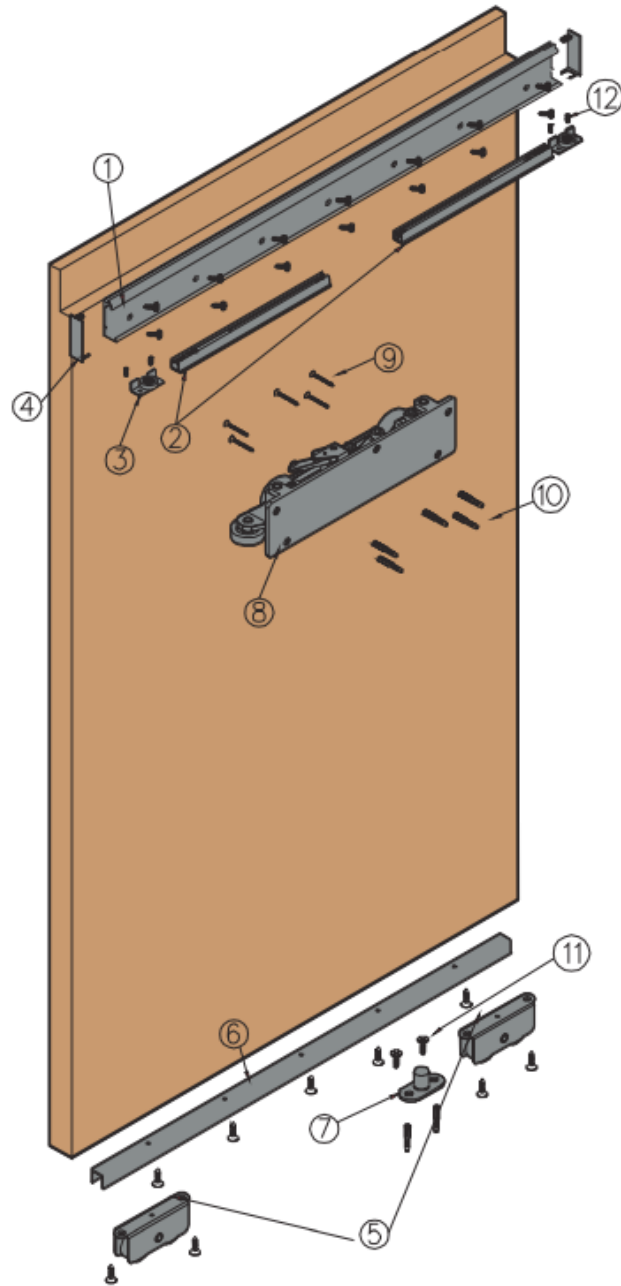

1. Trilho superior



2. Amortecedor

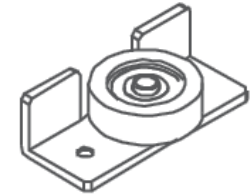

3. Carro lateral

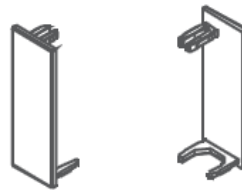

4. Tampas de acabamento

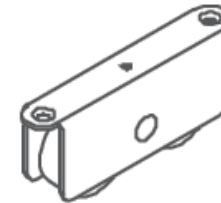

5. Carro inferior



6. Trilho inferior

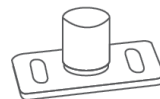

7. Guia inferior

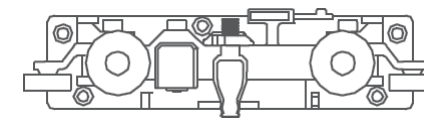

8. Carro superior



## COMPOSIÇÃO DO KIT: QUANTIDADE

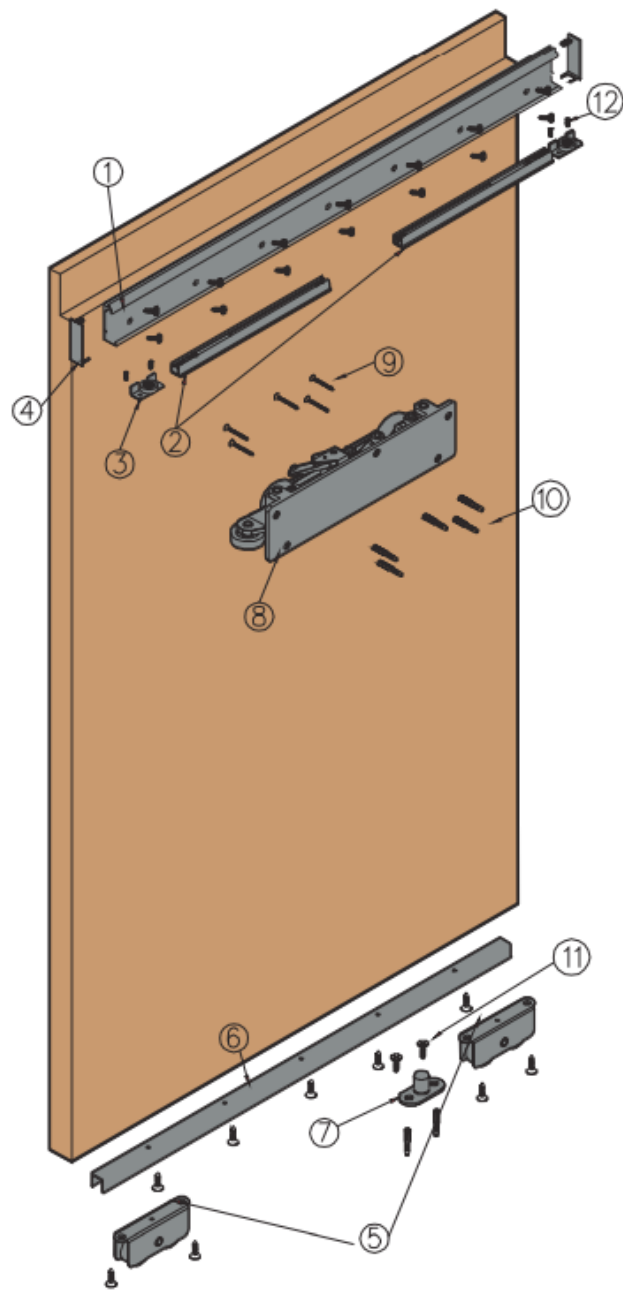

1		Trilho superior <i>Riel superior</i>	1
2		Amortecedor <i>Amortiguador</i>	2
3		Carro lateral <i>Carro lateral</i>	2
4		Tampas de acabamento <i>Tapas de acabado</i>	1
5		Carro inferior <i>Carro inferior</i>	2
6		Trilho inferior <i>Riel inferior</i>	1
7		Guia inferior <i>Guía inferior</i>	1

8		Carro superior <i>Carro superior</i>	1
9		Parafuso philips <i>Tornillo philips</i> ST 4,5 x 40	5
10		Bucha <i>Buje</i>	5
11		Parafuso philips <i>Tornillo philips</i> ST 4 x 16	25
12		Parafuso fixo hexagonal <i>Tornillo hexagonal fijado</i> M4 x 6	4
		Chave allen <i>Llave allen</i> 2 mm	1
		Chave allen <i>Llave allen</i> 4 mm	1



## O Sistema Volare conta com 3 tipos de aplicações:

1. Embutida
2. Embutida + rodapé
3. Sobreposta

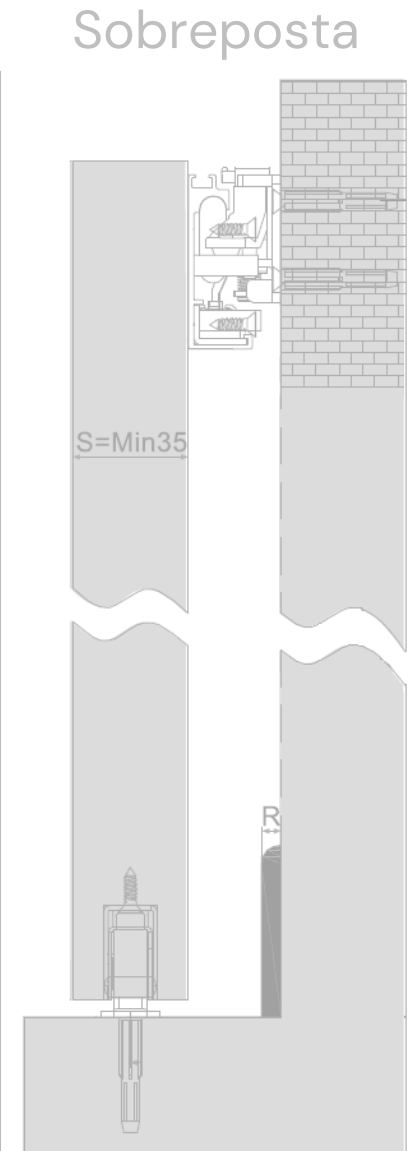
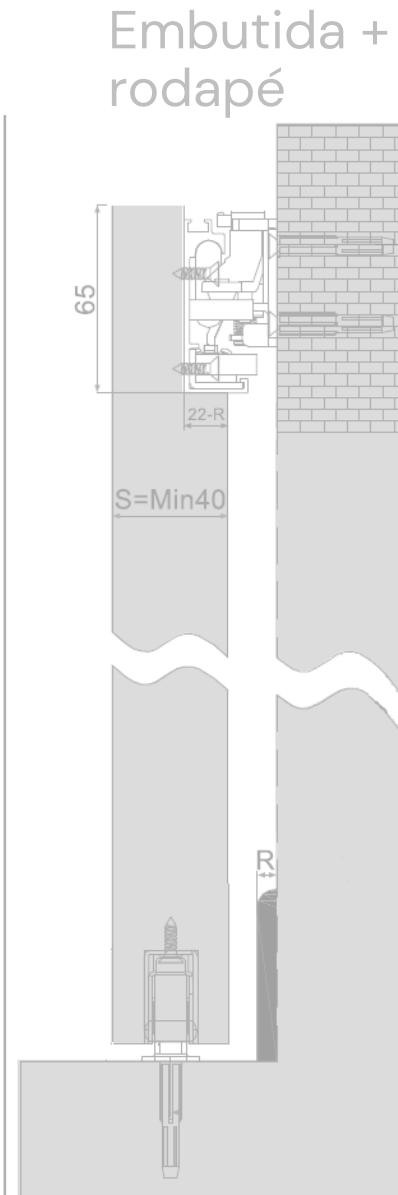
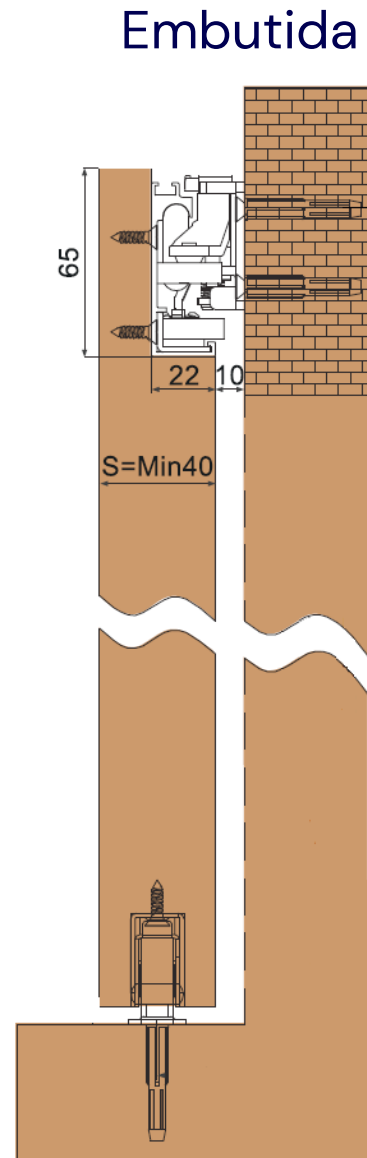



**O Sistema Volare conta com  
3 tipos de aplicações:**

1. Embutida
2. Embutida + rodapé
3. Sobreposta

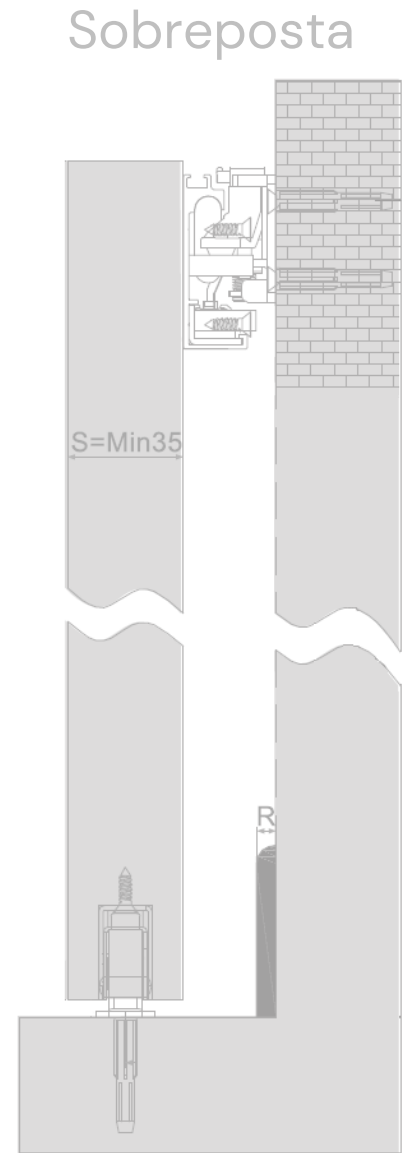
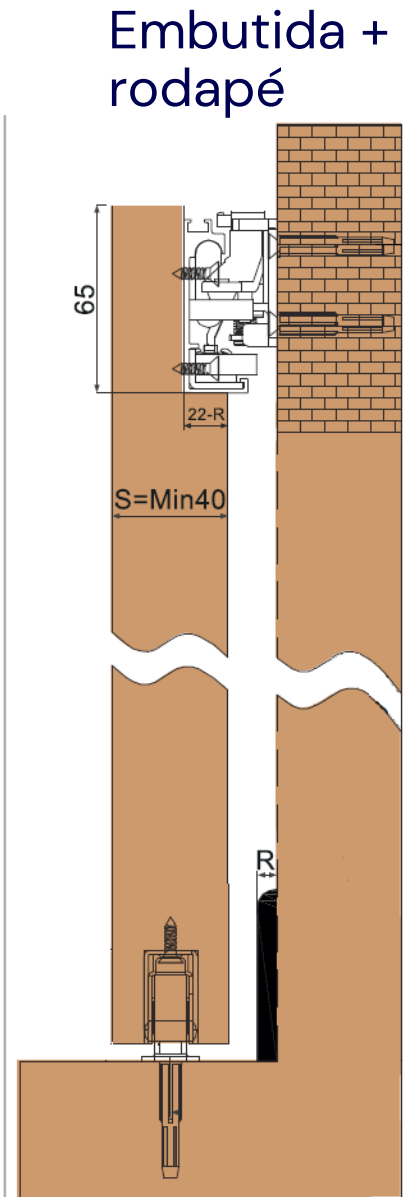



## O Sistema Volare conta com 3 tipos de aplicações:

1. Embutida
2. Embutida + rodapé
3. Sobreposta

### Embutida

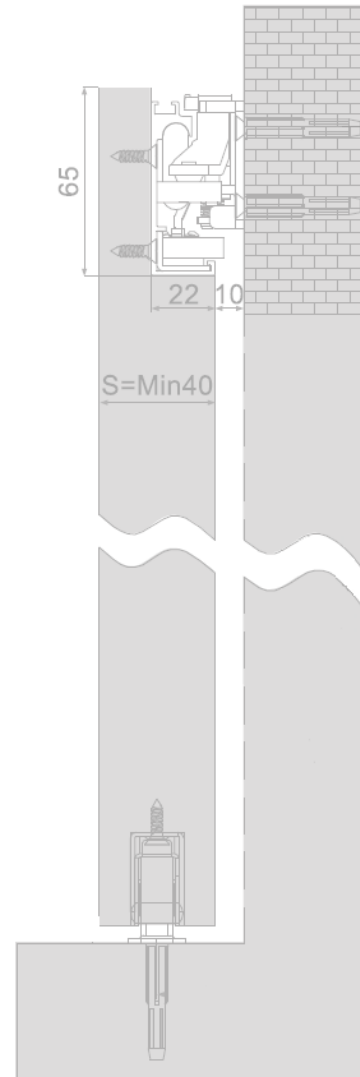

### Embutida + rodapé



### Sobreposta

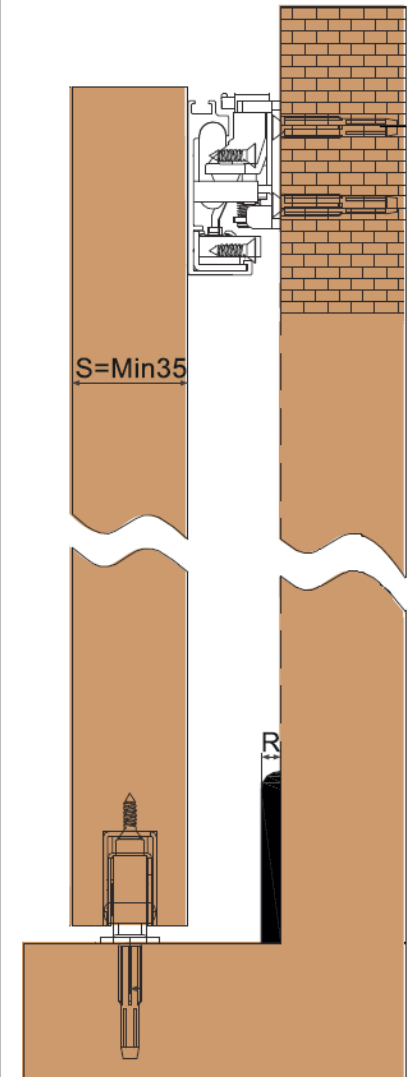



# VOLARE

Inteligência em movimento!





### **Rometal Sistemas**

Rodovia BR 470 | km 174,5 | nº 4075  
Bairro Universal | CEP 95330-000  
Veranópolis | RS | Brasil

### **Rometal Alumínio**

Estrada Velha da Vacaria | nº 1339  
Bairro Sapopema | CEP 95330-000  
Veranópolis | RS | Brasil

**Fone: +55 54 3441.3100**

**[www.rometal.com.br](http://www.rometal.com.br)**

